

StarPro Illuminator

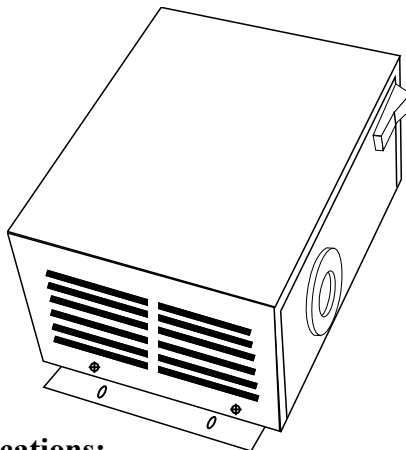

Specifications:

Application:	Dry Locations UL Listed. Horizontal/Vertical Surface Mount Only.
Dimensions:	12.50"L x 8.44"W x 6.36"H 317.5mm x 212.3mm x 161.5mm
Operating Temperature:	-20° F ~ 110° F / -29° C ~ 44 C°
Working Voltage:	120VAC 60Hz / 0.9 Amps (US Market) 240VAC 50Hz / 0.45 Amps (EUR Market)
Fiber Capacity:	2500, (0.75mm Fibers EndGlow® & 500 SideGlow®)
Lamp:	75 Watt Metal Halide Lamp
Average Lamp Life:	4.000 Hours
Weight:	7.0 lbs. / 3.17 Kg.
Ventilation:	115CFM Enclosed Cooling 24" Distance From Another Light Source
Finish:	Powder Coating (Black) Corrosion and Chemical Resistant
Warranty:	1 Year (Excluding Lamp)

Installation Manual

Rev. B 4-01-2005

General Information:

Model: StarPro

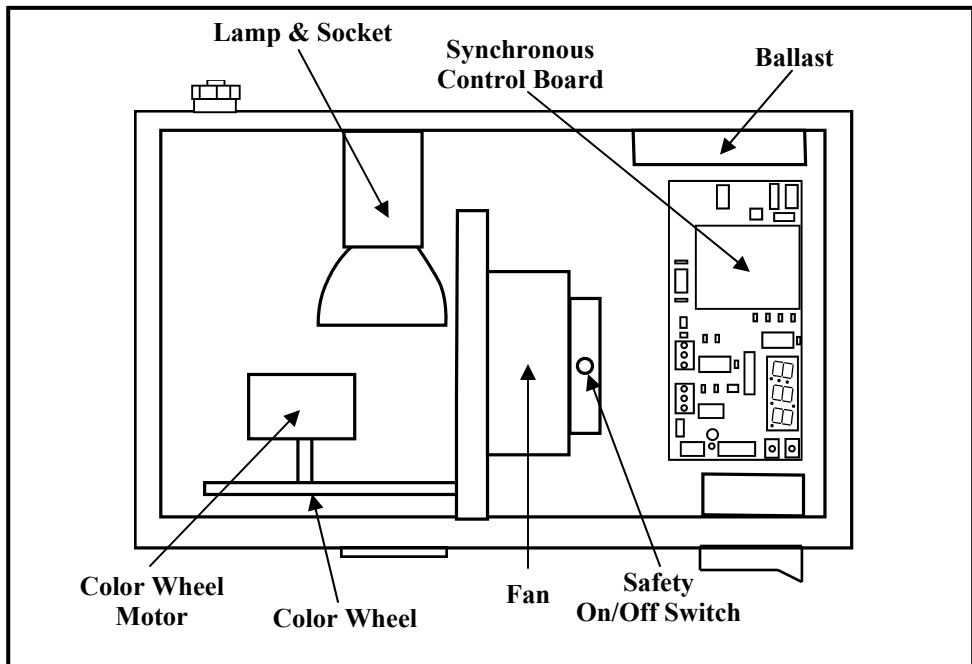
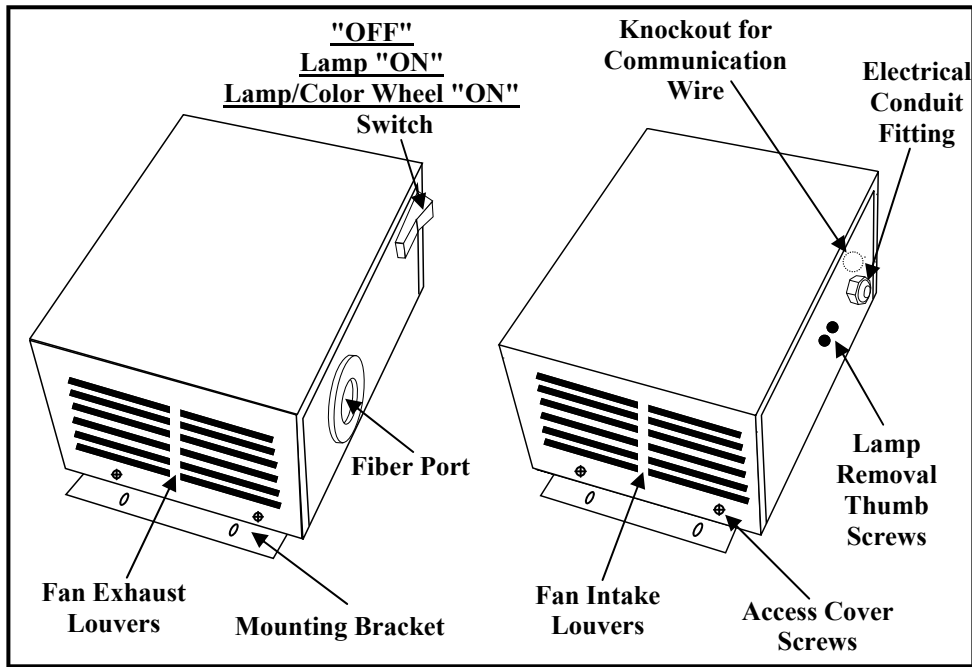

General Information: Con'd

Model: StarPro

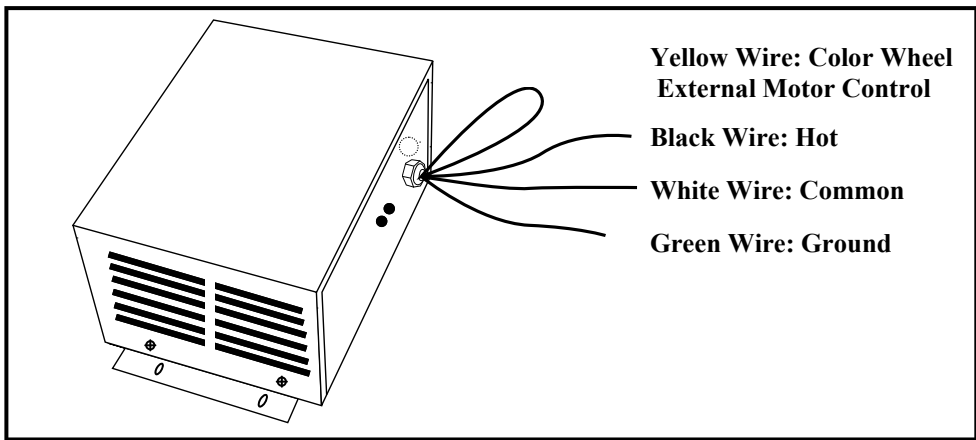
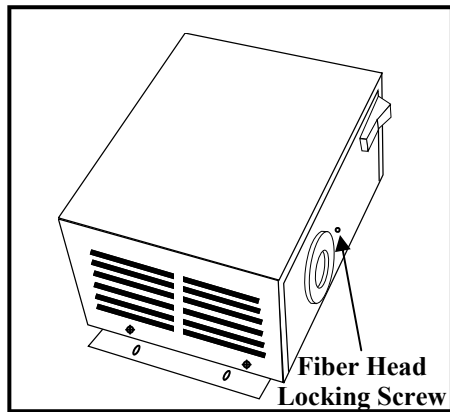
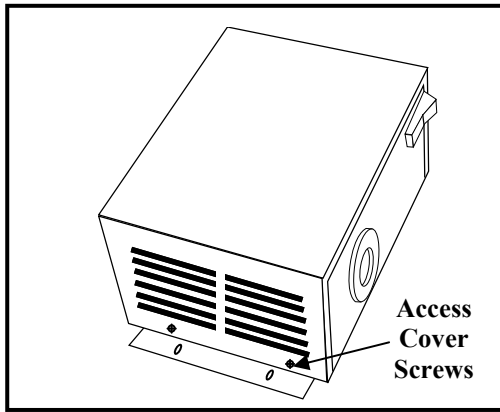
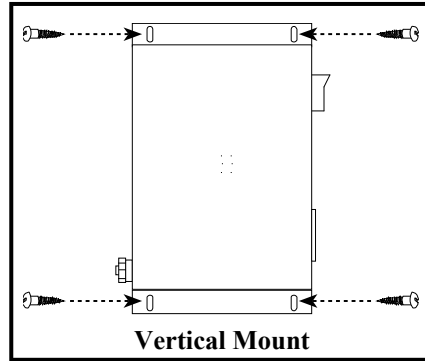
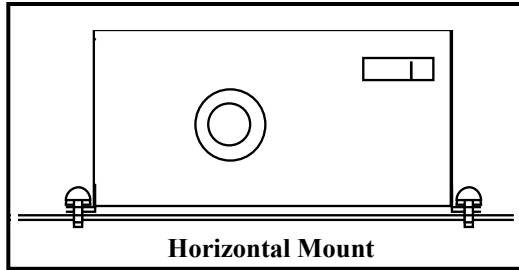

Fiber Head Preparation and Assembly of EndGlow® Model: StarPro

Prepare/Install Fiber Head for EndGlow® Application

Fiber Head Capacity:
2500 Fibers/0.75mm Fibers

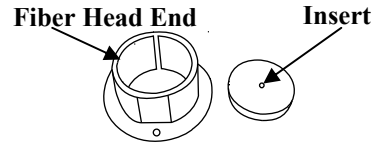
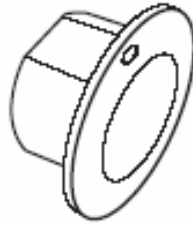

The amount of fiber that is inserted into the fiber head does not completely fill the fiber head, an insert is required. Drill hole into insert the diameter that is required. Install insert into fiber head by pressing until flush with end of fiber head.

Cutting Fiber Jacket

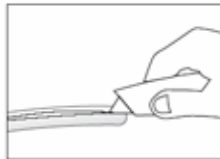

Cut protective jacket lengthwise, being careful not to cut or damage fibers.

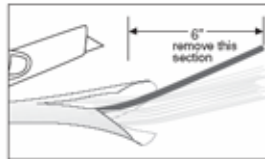

Remove approximately 6" of the protective jacket.

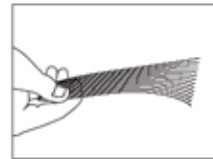

Inspect fibers for damaged. Re-cut as required.

Preparing Fiber Strands

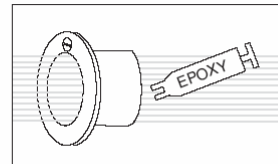
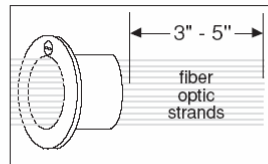

Apply epoxy to fiber strands and slide fiber head over strands as shown.

Cutting Fiber Strands

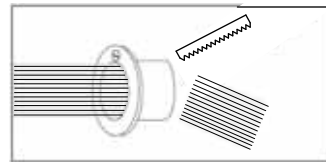

After Epoxy as completely cured. Cut fibers flush with fiber head end using a hack saw blade or any fine tooth saw blade.

Preparing Fiber Head

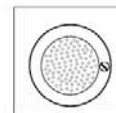
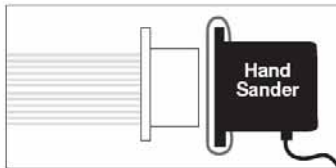

After sanding fiber strands flush with fiber head end, check that fiber strands are sanded smoothly.

Installing Fiber Head

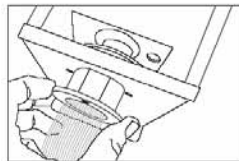

Locate two flat surfaces on fiber head align flats with fiber port on chassis, insert fiber head and turn to align. Install screw.

IMPORTANT NOTE:
Do not push the black jacket portion of the cable into the Fiber Head. Overheating and melting of the fiber may occur.

Control System:(Optional)

Model: StarPro

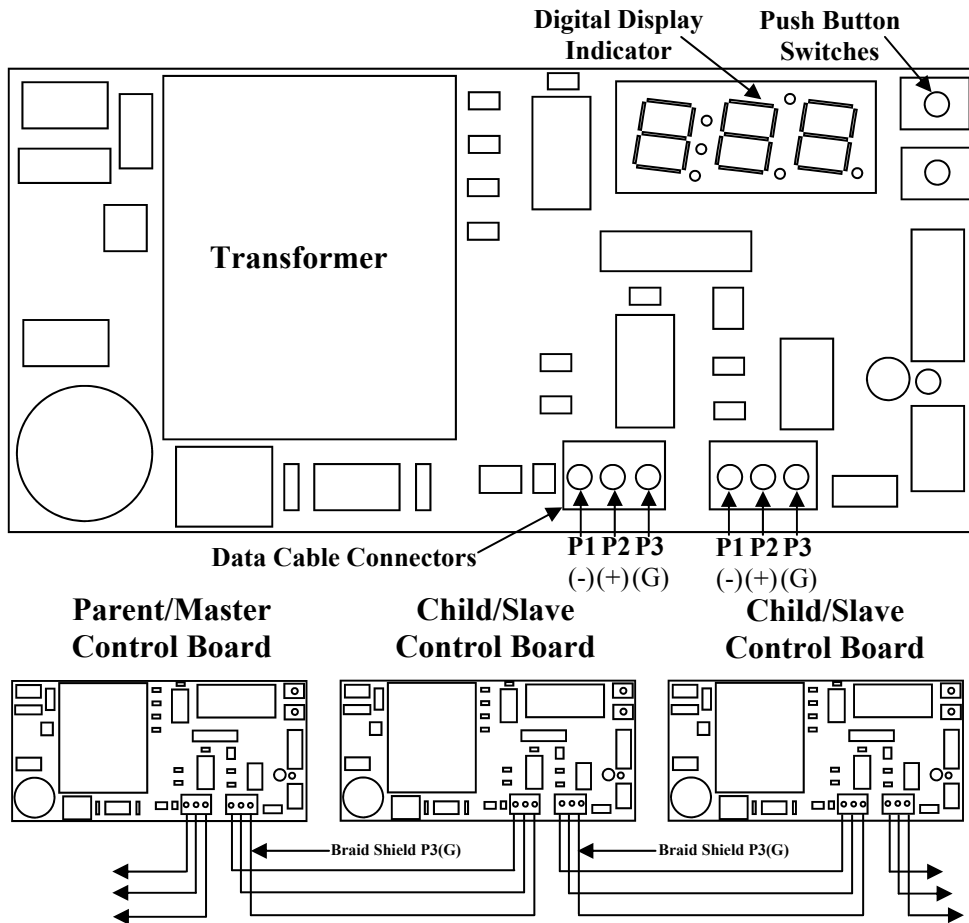

Connecting your illuminators together is a very simple process. First, you need to determine which unit will be your Parent/Master unit. All other units will become Child/Slave units. Inside each of your units there is a Data Control Board. Each board has two Data Cable Connectors that are used to link your units together. Each connector has three connection screws, they are P1(-), P2(+) and P3(G). Strip back the jacket on the Data Cable approximately 2 inches, inside the cable their are three smaller wires, strip back the wires approximately 1/4 inch on both ends of the cable. These three wires will be used to connect your units together. Insert the three wires into the Parent/Master Control Board connector P1(-), P2(+) and P3(G) as shown, make sure the Braided Shield wire is always connected to the (P3) connector, tighten down screws firmly. Take the other end of your Data Cable and insert the wires into the Child/Slave unit connector as shown.

Note: It is imperative that the wires you place into the P1, P2 and P3 connector on each unit are the same wire ends. Continue to connect all units, using the same method.

Note: When powering up units if you receive a "ER1" error message on the any digital display, that unit is wired incorrectly. (See trouble shooting section.) **Note:** Any cable rated by the manufacturer that compiles with the EIA-485 may be substituted.

Examples: Suitable cables include Belden 9841 or 9842, Proplex PC22P or PC224P and Alpha 9817.

Control System: (Optional) Con'd

Model: StarPro

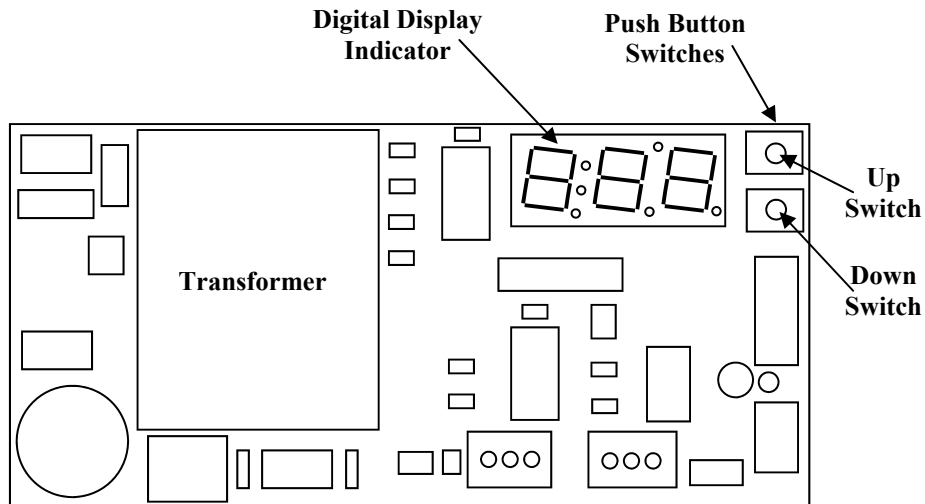

By depressing either of the push button switches up or down on the control board, you can change your Illuminator to a Parent/Master or Child/Slave unit and/or activate specific color wheel time delays per the Modes Table below. When in program mode, units can run continuously or be delayed up to 1 hour. Each selected program mode will be displayed on the digital display indicator of the Parent/Master Unit only.

Note: It is recommended after every mode change, cycle power **ON and OFF** .

Program Designator	Program Modes	Color Wheel Time Delay
C	Child/Slave	N/A
P c	Parent/Master	Continuous Rotation
P 1	Parent/Master	10 Second Delay
P 2	Parent/Master	30 Second Delay
P 3	Parent/Master	1 Minute Delay
P 4	Parent/Master	30 Minute Delay
P 5	Parent/Master	1 Hour Delay

Modes Table

Control System:(Optional) Con'd

Model: StarPro

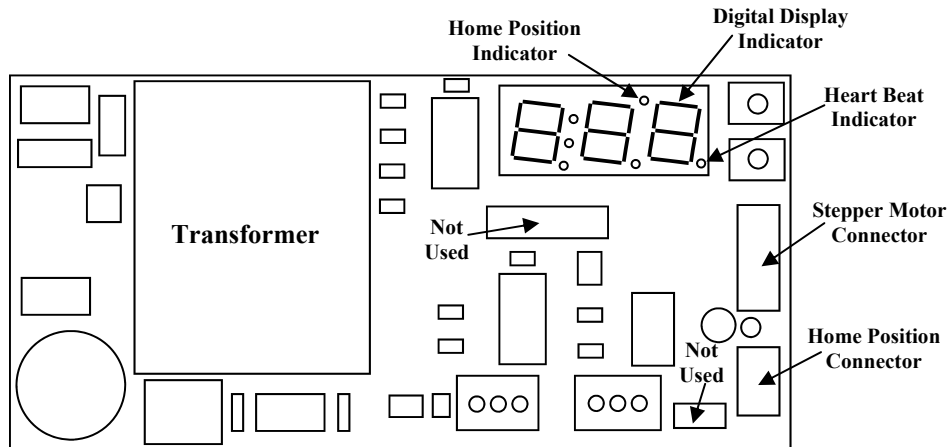

Home Position Indicator:

Turn power "ON" to all units, each unit will go into what is refer to as a synchronous faze, a "SYN" will be displayed on the Parent/Master unit digital display indicator and a "C" will be displayed on the Child/Slave units digital display indicator. Each color wheel on all units will begin to rotate, they are now looking for their Home Positions. Once all units have found their Home Position the color wheel will stop and the Home Position Indicator light will illuminate in red. At this point the Parent/Master unit will now go into its program mode. **Note:** From start up to program mode there is a 30 second time delay. **Note:** If at any time a unit or units can not find their Home Positions the unit will display a "ERO", error message on the digital display. (See trouble shooting section.)

Heart Beat Indicator:

Once all units have found their Home Position, the Parent/Master unit will go into its Program Mode as selected. When the Master unit starts to communicate program data to the Child/Slave units the Heart Beat indicator will begin to flash continuously, indicating there is proper communication between the Parent/Master unit and Child/Slave units. **Note:** The Heart Beat Indicator will flash continuously on the Child/Slave units only.

E R O	Home Position Error - Unit can not find Home Position.
E R 1	Serial Data Link Error – Unit or Units wired incorrectly.

Error Message Table

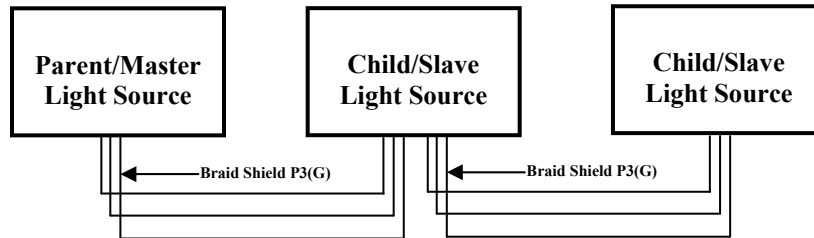

Caution !

Always run data cable in separate conduit, away from voltage wires.

Lamp Replacement:

Replacement Lamp Part No. GA-30 or GA-40

Step 1- Shut off main power to unit.

Step 2- Remove access cover.

Step 3 - Loosen/Remove lamp thumb screws.

Step 4 - Unscrew/Remove lamp from ceramic socket.

Step 5 - For lamp replacement complete steps 1,2,3,4 in reverse order.

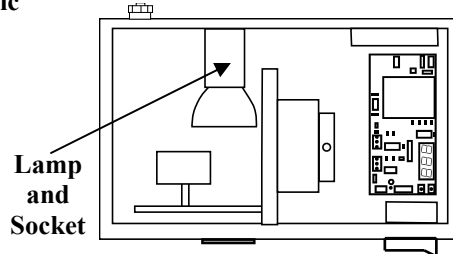
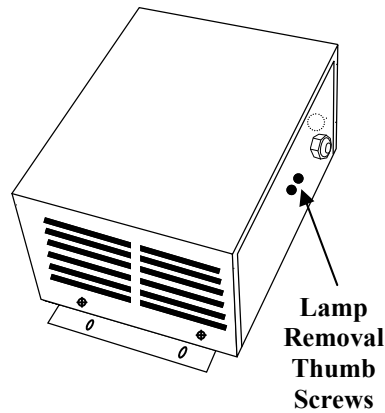

Trouble Shooting:

Model: StarPro

Important: The re-strike period is 5-10 minutes when the lamp is hot! This is the normal operation of this lamp.

- Light source will not operate:
 - Check if power switch is in the "ON" position.
- Lamp is OFF, fan is "ON":
 - Shut OFF the light source immediately and check the lamp connections.
 - If lamp is not "ON", replace lamp.
- Lamp is On, fan is "OFF":
 - Shut OFF the light source immediately and call a Service Representative.
- Light source does not change color:
 - Check color wheel for obstructions.
 - Check color wheel nut for tightness
- Light dims over a period of time:
 - Inspect the fiber head for a clean and smooth cut.
 - Fiber is melted at the fiber head
 - Check if fan is running
 - Check for proper ventilation
 - Check if the EndGlow® black jacket is in the Fiber Head. Remove black jacket and re-cut the fiber head.
- Light source shuts OFF after running for a period of time:
 - Check if fan is running.
 - Check for proper ventilation and ventilation obstructions.
- Error message on digital display:
 - "ERO" Home Position Error - Unit can not find Home Position. Check home position sensor wiring is plugged into connector.
 - "ER1" Serial Data Link Error - Unit or Units wired incorrectly. Check wiring from unit to unit.



SUPER | VISION
INTERNATIONAL